

Data Sheet



Article number: 2307084049

Description: E+G Position indicator
DD51-AN-00.25-D-C3 (grey)

Measures

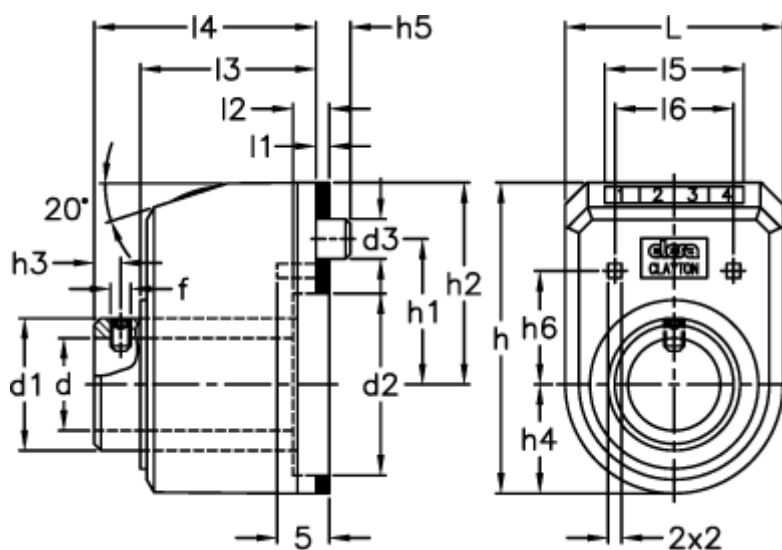

d1 = 20	h3 = 3.4	l4 = 33
d2 = 27.5	h4 = 16.5	l5 = 21
d3 = 6	h5 = 5.2	l6 = 16
d H7 = 14	h6 = 18	Max rpm = 1000
f = M4	L = 33	
h = 47	l1 = 2	
h1 = 22	l2 = 3.5	
h2 = 30.5	l3 = 26	